

CHAPTER 9 TABLE OF CONTENTS

9.0 SLINGS..... 3

 9.1 SCOPE..... 3

 9.2 GENERAL..... 3

 9.2.1 Guidelines 3

 9.2.2 Alloy Steel Chain Slings 5

 9.2.3 Wire Rope Slings 12

 9.2.4 Metal Mesh Slings..... 25

 9.2.5 Synthetic Web Slings 29

LIST OF FIGURES

9-1 Sling Stresses at Various Sling Angles 4

9-2 Chain Sling Major Components 6

9-3 Typical Wire Rope Slings 14

9-4 Nominal End Attachment Efficiency..... 15

9-5 Wire Rope Efficiencies for Various D/d Ratios 17

9-6 Rigging Tackle and Equipment Identification Tag Example 18

9-7 Correct and Incorrect Ways to Use Wire Rope Clips (Clamps)..... 24

9-8 Metal Mesh Fabric 26

9-9 Metal Mesh Sling..... 26

9-10 Synthetic Web Slings 31

9-11 Web Sling With Loop Eyes or End Fittings..... 32

LIST OF TABLES

9-1 Rated Load for Alloy Steel Chain Slings ASTM A391 7

9-2 Typical Reduction of Chain Sling Working Load
According to Temperature..... 8

9-3 Frequent and Periodic Inspection of Chain Slings9

9-4 Maximum Allowable Wear at any Point of Link 10

9-5 Wire Rope Slings in Choker Hitch..... 16

9-6 Allowable Broken Wires in Braided and Cable-Laid Slings 21

9.0 SLINGS

9.1 SCOPE

This section addresses the requirements for lifting slings manufactured from the following materials:

- Alloy steel chain (presented in para 9.2.2)
- Wire rope (presented in para 9.2.3)
- Metal mesh (presented in para 9.2.4)
- Sewn synthetic web (presented in para 9.2.5).

9.2 GENERAL

9.2.1 Guidelines

Slings, other than those described in this section, such as polyester round slings and Kevlar¹ fiber (yarn) slings, shall be used in accordance with recommendations of the sling manufacturer. Slings manufactured from conventional three-strand natural or synthetic fiber rope are not recommended for use in lifting service. Natural or synthetic fiber rope slings shall be used only if other sling types are not suitable for the unique application. For natural or synthetic rope slings, the requirements of ASME B30.9, Chapter 9-4, and OSHA 1910.184(h) shall be followed. All types of slings shall have, as a minimum, the rated capacity clearly and permanently marked on each sling. Each sling shall receive a documented inspection at least annually, more frequently if recommended by the manufacturer or made necessary by service conditions.

9.2.1.1 Defective Slings. Slings to be repaired and recertified shall be stored in a secure manner that renders them inaccessible for use while repair is pending. Unless defective slings are to be repaired and recertified, they shall be destroyed to prevent future use.

9.2.1.2 Multiple Leg Slings. When lifting rigid objects with multiple-leg slings (three or four legs), two of the legs should be capable of supporting the total load. Multiple-leg slings shall be selected to suit the most heavily loaded leg rather than the total weight.

9.2.1.3 Sling Angles. A key factor in determining sling stress is sling angles (Fig. 9-1.)

9.2.1.4 Periodic Load Tests. Periodic load testing of slings is not recommended.

¹Kevlar is a registered trademark of DuPont de Nemours and Company.

Figure 9-1. Sling Stresses at Various Sling Angles (Sling Angles Less than 30E Not Recommended).

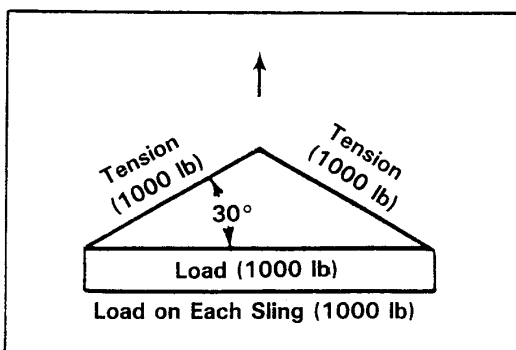
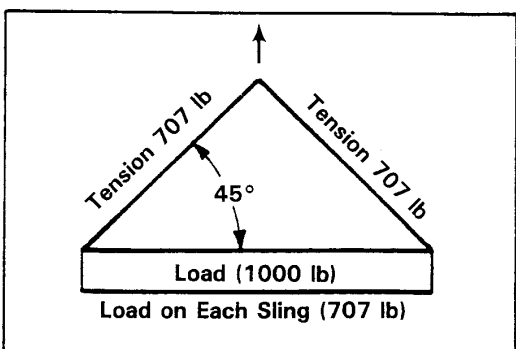
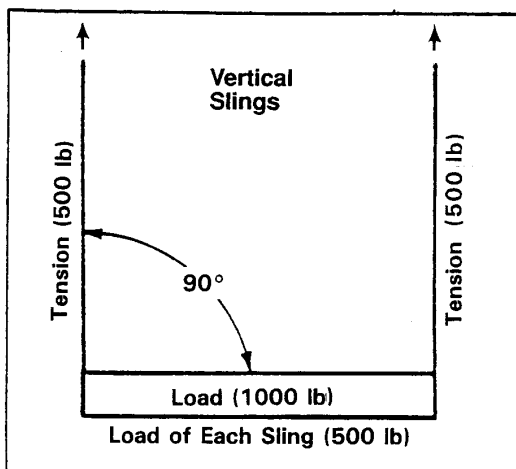

$$\text{Tension in Each Leg} = \frac{\text{Load}}{2} \times \text{Load Angle Factor}$$

Horizontal Sling Angle	Load Angle Factor
90°	1.000
85°	1.004
80°	1.015
75°	1.035
70°	1.064
65°	1.104
60°	1.155
55°	1.221
50°	1.305
45°	1.414
40°	1.555
35°	1.742
30°	2.000
25°	2.364
20°	2.924
15°	3.861
10°	5.747
5°	11.490

Not Recommended
↓

9.2.2 Alloy Steel Chain Slings

9.2.2.1 Design Factors and Chain Properties. Chain for alloy steel chain slings shall conform to the requirements of ASTM A391/A 391M, *Standard Specification for Grade 80 Alloy Steel Chain*. Rated loads for alloy steel chain slings shall be based on a minimum design factor of 4.

The general configuration of a chain sling is shown in Fig. 9-2.

9.2.2.2 Rated Loads. The rated loads for alloy steel chain slings are presented in Table 9-1.

9.2.2.3 Sling Identification. Alloy steel chain slings shall be labeled by the manufacturer with permanently affixed durable identification stating the following:

1. Chain size
2. Manufacturer's grade (Only ASTM A 391 is allowed for lifting purposes).
3. Rated load and angle upon which the rating is based
4. Reach
5. Number of legs
6. Manufacturer's name or trademark
7. An additional tag, sticker, or other identifier shall be added by the user to indicate when the next periodic inspection is required.

9.2.2.4 Effects of Environment. Environmental limits for alloy steel chain slings are listed in Table 9-2 and are presented below:

1. If the chain sling becomes heated to a temperature of 400 EF (204 EC), rated loads shall be reduced in accordance with the chain manufacturer's recommendations regarding usage both while heated and after being heated.
2. If the chain slings are to be used in temperatures of -40 EF (-40 EC) or less, the manufacturer should be consulted.

9.2.2.5 Attachments. Requirements for attachments to alloy steel chain slings follow:

1. Hooks, rings, oblong links, pear-shaped links, mechanical coupling links, or other attachments shall have a rated load at least equal to that of the alloy steel chain with which they are used. In cases where the particular use makes this impractical, the sling shall be marked with a rated load (working load limit) that is consistent with the least working load rating of any component.

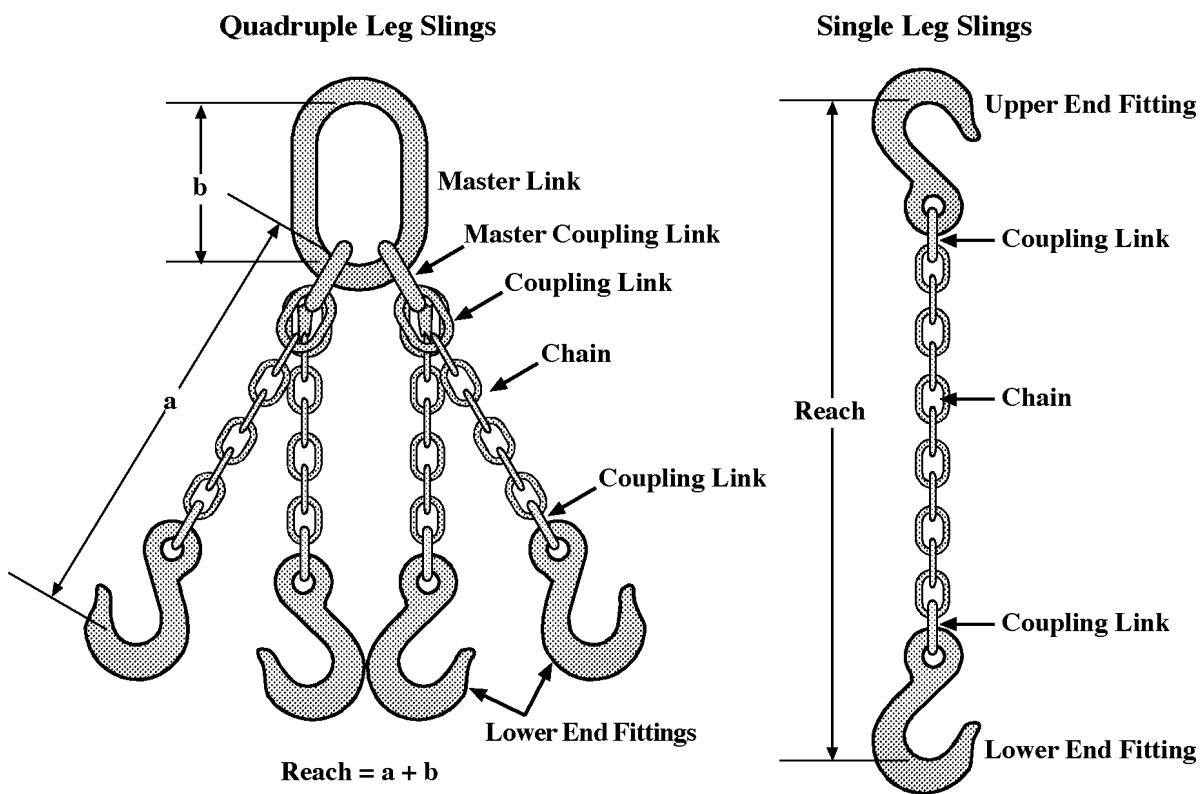

RG99020168.1

Figure 9-2. Chain Sling Major Components.

Table 9-1. Rated Load for Alloy Steel Chain Slings ASTM A391.

Chain Size Nominal ¹	Single Leg Sling— 90° to Horizontal Loading		Rated Load Horizontal Angle							
	in	mm	lb	kg	lb	kg	lb	kg		
9/32	7	1,570	3,500	1,570	6,100	2,700	4,900	2,200	3,500	1,590
3/8	10	3,200	7,100	3,200	12,300	5,500	10,000	4,500	7,100	3,200
1/2	13	5,400	12,000	5,400	20,800	9,400	17,000	7,600	12,000	5,400
5/8	16	8,200	18,100	8,200	31,300	14,200	25,600	11,600	18,100	8,200
3/4	20	12,800	28,300	12,800	49,000	22,300	40,000	18,200	28,300	12,900
7/8	22	15,500	34,200	15,500	59,200	27,200	48,400	22,200	34,200	15,700
1	26	21,600	47,700	21,600	82,600	37,900	67,400	31,000	47,700	21,900
1-1/4	32	32,800	72,300	32,800	125,200	56,800	102,200	46,400	72,300	32,800

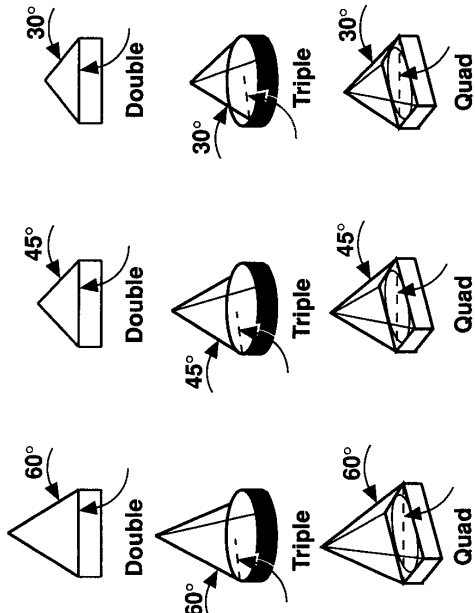

¹ Other grades of proof tested steel chain include Proof of Coil (Grade 28), Hi-Test (Grade 43) Chain, and Transport (Grade 70) Chain. These grades are not recommended for overhead lifting, and therefore, are not covered in this table.
² Rating of multileg slings adjusted for angle of loading between the inclined leg and the horizontal plane of the load.
³ Triple and quadruple sling rating is the same as double sling rating because normal lifting practice may not distribute the load uniformly on all legs, leaving only two legs to carry the load. If rigging techniques, verified by a qualified rigger or rigging specialist, ensure the load is evenly distributed, then full use of three legs is allowed. Special rigging techniques verified by a qualified engineer shall be required to prove a load is evenly distributed over four or more sling legs.

Table 9-2. Typical Reduction of Chain Sling Working Load According to Temperature.^a

Temperature of chain (EF)	Reduction in working load (%)	
	While heated	After cooling
400	10	10
500	10	10
600	20	10
700	25	10
800	45	10
900	55	15
1,000	60	20

^aThis table is provided for information and may not reflect specific chain sling manufacturer's recommendations. It is important that the manufacturer be contacted if a chain sling will be used at temperatures of 400 EF or more.

2. Standard attachments should be of a size recommended by the sling manufacturer.
3. All welded components in the sling assembly shall be proof-load tested as components or as part of the sling assembly.
4. Makeshift fasteners, hooks, or links formed from bolts or rods shall not be used. Nonstandard end fittings designed by a qualified engineer may be used.
5. Where used, handles shall be welded to the master link or hook before heat treating. (This prohibits welding on chain slings during field operations.)

9.2.2.6 Chain Sling Inspection.

9.2.2.6.1 Initial Inspection. Before use, all new, altered, modified, or repaired slings shall be inspected by a designated person to ensure compliance with the requirements of para 9.2.2.1 and 9.2.2.5.

9.2.2.6.2 Frequent and Periodic Inspection. Inspection of chain slings in regular service is divided into two general classifications based on the interval at which inspection should be performed. The intervals, in turn, are dependent on the degree of exposure of the sling components to wear and deterioration. The two general classifications are designated as “frequent” and “periodic,” with respective intervals between inspections as defined in Table 9-3.

1. Frequent Inspection. Slings shall be inspected for defects and damage at intervals as defined in Table 9-3. In addition, the following visual observations should be conducted during regular service to ensure that no damage or evidence of malfunction appears between regular inspections. Any such deficiencies shall cause the sling to be set aside for periodic inspection.

Table 9-3. Frequent and Periodic Inspection of Chain Slings.

Service level	Sling service	Frequent inspection ^a	Periodic inspection ^b
Normal	Service that involves use of loads within the rated load	Monthly	Yearly
Severe	Service that involves normal service coupled with abnormal operating conditions	Daily to weekly	Monthly to quarterly
Special or infrequent	Service that involves operation, other than normal or severe, which is recommended by a qualified individual	Before and after each occurrence	Before each occurrence or sequence of occurrences within a 30-day period

^aVisual examinations by the user with records not required.

^bVisual inspection by a qualified inspector making a record of the inspection or of apparent conditions to provide the basis for a continuing evaluation.

- a. Chain and attachments should display no wear, nicks, cracks, breaks, gouges, stretch, bends, weld splatter, discoloration from excessive temperature, or excessive throat opening of hooks. Chain links and attachments shall hinge freely with adjacent links. Latches on hooks, if present, should hinge freely and seat properly without evidence of permanent distortion.
 - b. The tag or other marking should be examined to verify periodic inspection is current (see para 9.2.2.3, Item 7).
2. Periodic Inspection. Complete link-by-link inspections of the slings shall be performed at the intervals defined in Table 9-3. Any deficiencies shall be examined and a determination made as to whether they constitute a hazard. These inspections shall include chain sling frequent inspection, as specified above, in addition to the following.

- a. Each link and attachment shall be individually examined, taking care to expose inner-link surfaces of the chain and chain attachments to inspect for those items defined for frequent inspection.
- b. Worn links shall not exceed the values in Table 9-4 or the values that are specifically recommended by the manufacturer.

Table 9-4. Maximum Allowable Wear at any Point of Link.

Nominal chain or coupling in size (in.)	Maximum allowable wear of cross-sectional diameter (in.)
9/32	3/64
3/8	5/64
1/2	7/64
5/8	9/64
3/4	10/64
7/8	11/64
1	12/64
1-1/4	16/64

NOTE: For other sizes, consult chain or sling manufacturer.

- c. Sharp transverse nicks and gouges shall be rounded by grinding,² and the depth of the gouge or rounded portion shall not exceed values provided in Table 9-4.
 - d. Hooks shall be inspected in accordance with para 10.1.5, "Rigging Hooks."
 - e. If present, latches on hooks should seat properly, rotate freely, and show no permanent distortion.
3. Documentation. The periodic inspection shall be documented by any one of the following methods:
 - a. Mark a serial number on the sling and maintain inspection records by serial numbers.
 - b. Institute a comprehensive marking program (such as color coding) to indicate when the next inspection is required.
 - c. Mark each sling with a tag that indicates when the next periodic inspection is required. This tag becomes the record.

²Removal of sharp transverse nicks and gouges on chain slings, within the limits of this manual, is considered maintenance, not repair.

9.2.2.7 Proof Test. New, repaired, or reconditioned chain slings, including welded components, shall be proof tested by the sling manufacturer or repair agency to twice the rated capacity. The sling custodian shall retain a certificate of the proof test and shall make it available to authorized personnel for examination.

The proof load for multiple-leg slings shall be applied to the individual legs and shall be twice the rated capacity of a single-leg sling.

Mechanically assembled slings need not be proof tested provided all components have been proof tested.

9.2.2.8 Repairs. Any hazardous condition disclosed during inspection or operation shall be corrected before the chain is used again. Chain repairs shall be made only by the chain manufacturer or qualified personnel.

When repairs are made, the following criteria shall be followed:

1. Alloy steel chain, attachments, and coupling links used for repair shall conform to the strength requirements and other requirements of the original sling. Cracked, broken, or bent links and attachments shall not be repaired; they shall be replaced.
2. When repaired, a sling shall be permanently marked to identify the repairing agency.
3. Mechanical coupling links or carbon steel repair links shall not be used to repair broken lengths of alloy chain.

9.2.2.9 Operating Practices. Operating practices and guidelines for the use of alloy steel chains are as follows:

1. Slings having suitable characteristics for the type of load, hitch, and environment shall be selected.
2. The weight of the load shall be within the rated load (working load limit) of the sling.
3. Chain slings shall not be shortened or lengthened by knotting, twisting, or other methods not approved by the sling manufacturer.
4. Slings that appear to be damaged shall not be used unless they are inspected and accepted as usable in accordance with the periodic inspection requirements stated above.
5. The sling shall be hitched or rigged in a manner providing control of the load.
6. Sharp corners in contact with the chain sling should be padded with material of sufficient strength to minimize damage to the sling.
7. Portions of the human body should be kept from between the sling and the load and from between the sling and the crane/hoist hook.
8. Personnel should stand clear of the suspended load.

9. Personnel shall not ride the sling.
10. Shock loading is prohibited.
11. Slings should not be pulled from under a load when the load is resting on the sling.
12. Slings should be stored in an area where they will not be subjected to mechanical damage, corrosive action, moisture, extreme heat, or kinking.
13. Twisting and kinking the legs (branches) shall be avoided.
14. The load applied to the hook should be centered in the bowl of hooks to prevent point loading on the hook, unless the hook is designed for point loading.
15. During lifting, with or without load, personnel shall be alert for possible snagging.
16. In basket hitch, the load should be balanced to prevent slippage.
17. The sling's legs (branches) should contain or support the load so that the load remains under control.
18. Multiple-leg (branch) chain slings shall be selected according to Table 9-1 when used at the specific angles given in the table. Operation at other angles shall be limited to rated loads of the next lower angle given in the table or calculated trigonometrically so as to not introduce into the leg (branch) itself a working load in direct tension greater than that permitted.
19. Slings should be long enough so that the rated load is adequate when the angle of the legs (branches) is taken into consideration.
20. Slings should not be dragged on the floor or over an abrasive surface.
21. When used in a choker hitch arrangement, slings shall be selected to prevent the load developed on any portion of the sling from exceeding the rated load of the chain sling components.
22. Before using a chain sling outside the temperature range of -40 EF to 400 EF (-40 EC to 204 EC), contact the sling manufacturer.

9.2.3 Wire Rope Slings

9.2.3.1 Wire Rope Grades. Wire rope slings are fabricated from various grades and types of wire rope. The manufacturer of the sling shall be consulted for specific data on the grade and type of rope used. The general configuration of the wire rope sling is shown in Fig. 9-3.

9.2.3.2 Wire Rope Sling Properties. Rated loads of wire rope slings shall be specified by the manufacturer, using a design factor of at least 5. Rated loads are based on the following factors:

1. Nominal wire rope strength
2. Nominal splicing and end attachment efficiency (see Fig. 9-4)

3. Angle of loading (see Fig. 9-1). The rated load (load-carrying ability required) is based on sling angles. If slings are not vertical, the load carrying ability is reduced:

rated load = vertical capacity X sine of minimum horizontal angle

<u>Sines</u>	
30E	- 0.500
45E	- 0.707
60E	- 0.866

4. If two or more slings are used, the least horizontal angle (greatest vertical angle) shall be considered.
5. Horizontal sling angles less than 30E (vertical angle more than 60E) should not be used.
6. Type of hitch (e.g., straight pull, choker hitch or basket hitch)
7. D/d ratio (see Fig. 9-5):
D = diameter of curvature around which rope is bent
d = diameter of rope.

Figure 9-3. Typical Wire Rope Slings.

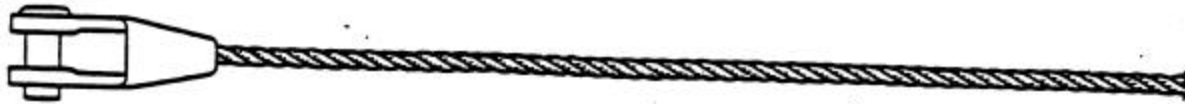

WIRE ROPE SOCKET - POURED SPECTER OR RESIN



WIRE ROPE SOCKET - SWAGED



MECHANICAL SPLICE - LOOP OR THIMBLE



CLIPS - NUMBER OF CLIPS VARIES WITH ROPE SIZE AND CONSTRUCTION



LOOP OR THIMBLE SPLICE - HAND TUCKED



a. Wire Rope Sockets-Spelter Attachment 100%

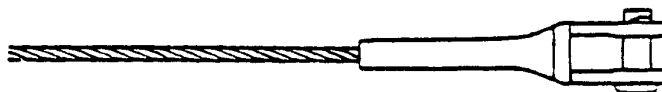

b. Wire Rope Sockets-Swaged 100%



c. "Swaged-Sleeve" Loop or Thimble Attachment-
 1 in. Diameter and Smaller 95%
 1 1/2 in. Diameter and Larger 92.5%



d. Loop or Thimble Splice (hand tucked)
 1/4 in.90% 3/8 in.88% 1/2 in. ...86% 3/4 in.82%
 5/16 in. .. 89% 7/16 in. ...87% 5/8 in. ...84% 7/8 in. and Larger 80%

38805-185.4

Figure 9-4. Nominal End Attachment Efficiency.

8. When a sling is used in a choker hitch, the angle formed in the rope body as it passed through the choking eye (the choke angle) should be 120E or greater. For smaller angles, the rated load shall be reduced as shown in Table 9-5:

Table 9-5. Wire Rope Slings in Choker Hitch.

Angle of choke (E)	Percentage of choker-rated load
120 to 180	100
90 to 119	87
60 to 89	74
30 to 59	62
0 to 29	49

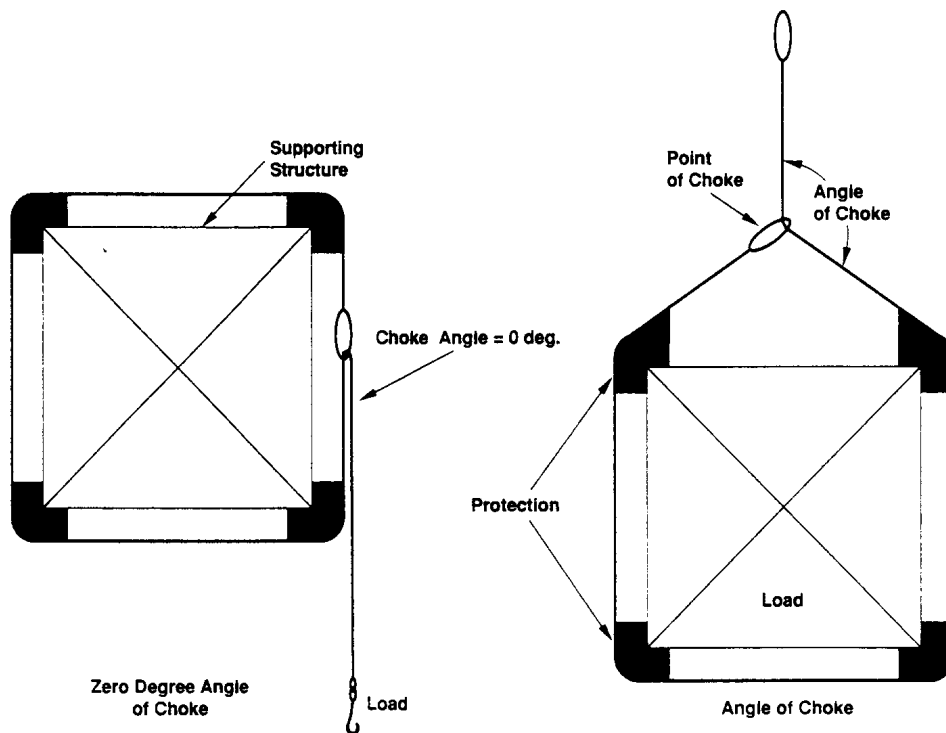
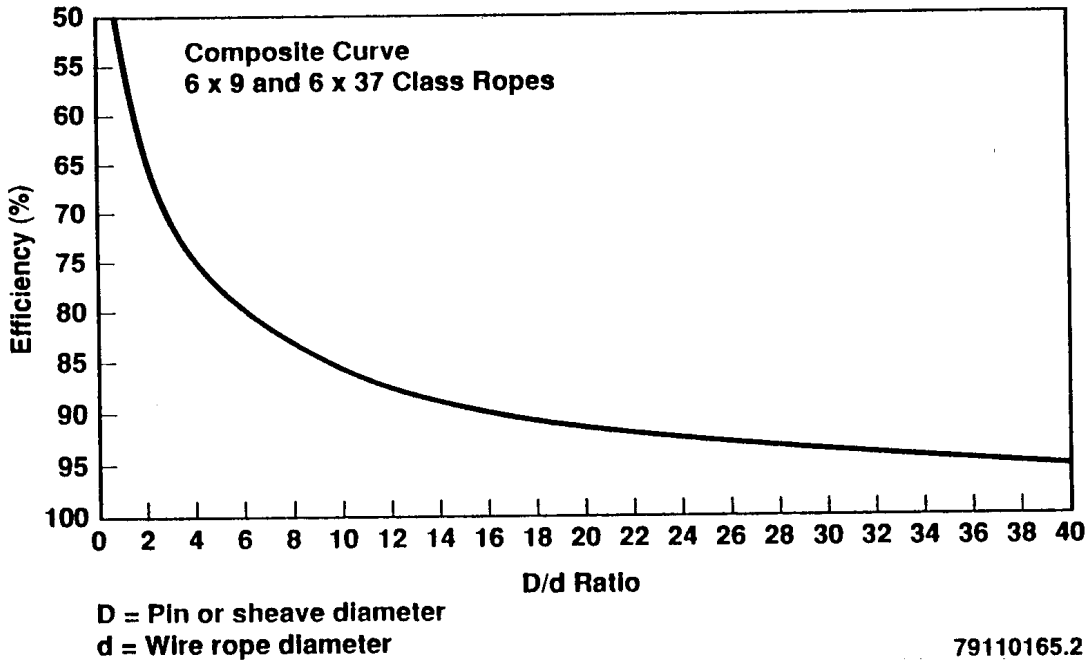

Figure 9-5. Wire Rope Efficiencies for Various D/d Ratios.



The strength reduction (efficiency) is based on the D/d ratio. For example, a rope bent around a pin of equal diameter will have a D/d ratio of 1. The efficiency will be 50 percent. The rope will have only 50 percent of the nominal strength attributed to it.

9.2.3.3 Proof Tests. Wire rope sling assemblies shall be proof tested using the following criteria:

1. Hand Tucked. The proof load for hand-tucked slings shall be a minimum of the rated load and shall not exceed 1.25 times the rated load.
2. Wire Rope Clips. The proof load for wire rope clip slings shall be a minimum of the rated load and shall not exceed two times the rated load (see para 10.1.2, "Wire Rope Clamps").
3. Others. The proof load for other types of slings including mechanical splice, zinc-poured, resin poured, and swagged socket shall be two times the vertical rated load.
4. Multiple Leg Slings. The proof load for multiple-leg bridle slings shall be applied to the individual legs. The proof load for the individual legs shall be consistent with the particular single-leg assembly stated above. Any master link to which multiple legs are connected shall be proof loaded to two times the force applied by the combined legs.

9.2.3.4 Sling Identification. Wire rope slings shall be labeled with a tag or other identification methods similar to that shown in Fig. 9-6. Other identification methods that provide the same information are acceptable. The tag, or other identification method, shall state the following:

1. Manufacturer's name
2. Rated load (rated capacity)
3. Load test date
4. Periodic inspection due date.

Figure 9-6. Rigging Tackle and Equipment Identification Tag Example.

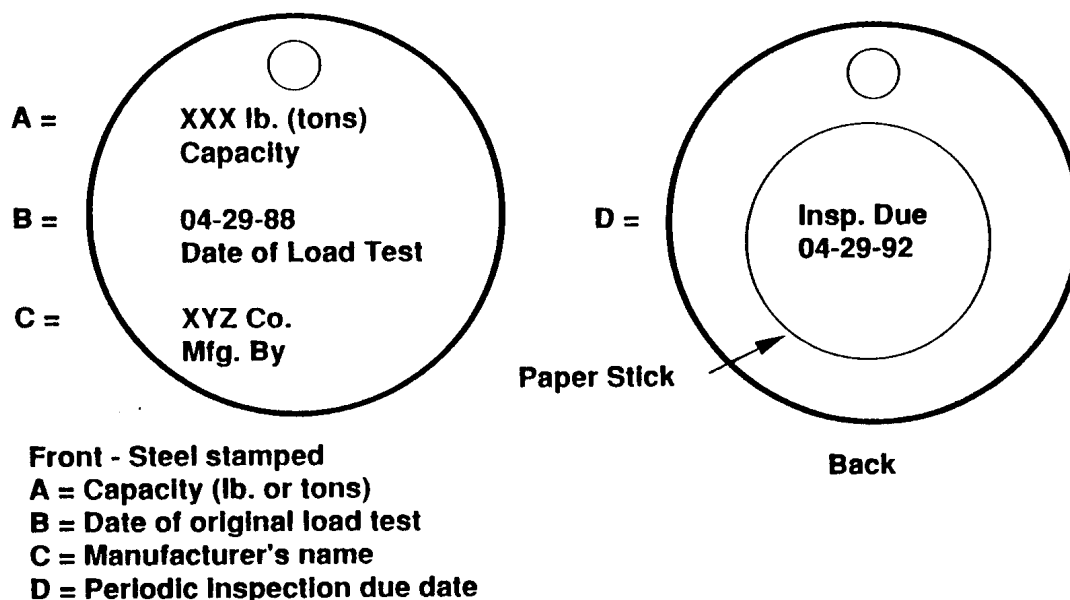

79110165.2

9.2.3.5 Effects of Environment. Damage from caustic or acid substances or fumes can affect wire rope sling length. A strongly oxidizing environment attacks common sling materials. The manufacturer, therefore, should be consulted before slings are used in chemically active environments. Specific environmental limits are as follows:

1. Fiber core wire rope slings of all grades shall not be exposed to temperatures in excess of 180 F (82 C) or less than -40 F (-40 C).
2. Wire rope slings of any grade shall be used only between 400 F (204 C) and -60 F (-51 C) unless written approval is obtained from the wire rope manufacturer.

9.2.3.6 Minimum Sling Lengths. Slings made of rope with a 6 X 19 and 6 X 37 construction, and cable-laid slings, shall have a minimum clear length of rope 10 times the rope diameter between splices, sleeves, or end fittings.

Braided slings shall have a minimum clear length of rope 40 times the component (individual) rope diameter between the loops or end fittings.

Grommets and endless slings shall have a minimum circumferential length of 96 times the body diameter of the grommet or endless sling.

9.2.3.7 End Attachments. Requirements for attachments to wire rope slings are presented below:

1. All welded load-bearing components (welded before or after assembly) in the sling shall have a design factor of 5:1 and shall be proof tested by the manufacturer or the manufacturer's agent to twice their rated load. The sling custodian shall retain proof test reports and shall make them available to authorized personnel for examination.
2. Welding of handles or any other accessories to end attachments, except covers to thimbles, shall be performed before assembling the sling.
3. Eyes in wire rope slings shall not be formed using knots.

9.2.3.8 Inspection and Replacement.

9.2.3.8.1 Frequent Inspection. Users shall visually inspect slings each day of use for gross damage, such as listed below, which may be an immediate hazard:

1. Distortion of rope in the sling such as kinking, crushing, unstranding, birdcaging, main strand displacement, or core protrusion. Loss of rope diameter in short rope lengths or unevenness of other strands should provide evidence the sling or slings should be replaced.
2. General corrosion
3. Broken or cut strands
4. Number, destruction, and type of visible broken wires (ten randomly distributed broken wires in one rope lay or five broken wires in one strand in one rope lay).

9.2.3.8.2 Periodic Inspection. A wire rope sling periodic inspection shall be performed by a qualified inspector on a regular basis (at least annually).

1. Inspection frequency shall be based on the following criteria:
 - a. Frequency of sling use
 - b. Severity of service conditions
 - c. Nature of lifts being made
 - d. Experience gained on the service life of slings used in similar circumstances.
2. The periodic inspection shall be documented by any one of the following methods:
 - a. Mark a serial number on the sling and maintaining inspection records by serial numbers.

- b. Institute a comprehensive marking program (such as color coding) to indicate when the next periodic inspection is required.
- c. Mark each sling with a tag that indicates when the next periodic inspection is required. This tag becomes the record.

The periodic inspection shall be performed by a qualified person. Inspection shall be conducted on the entire length of each sling including splices, end attachments, and fittings. Deterioration that would result in loss of original strength shall be observed and determination made whether further use of the sling would constitute a hazard.

9.2.3.8.3 Replacement. Wire rope slings shall be immediately removed from service if any of the following conditions are present (see para 9.2.1.1):

1. For strand-laid and single-part slings, ten randomly distributed broken wires in one rope lay or five broken wires in one strand in one rope lay
2. Broken wires in braided and cable-laid slings (Table 9-6)
3. Severe localized abrasion or scraping of one-third the original diameter of outside individual wires
4. Kinking, crushing, birdcaging, or any other damage resulting in distortion of the rope structure

Table 9-6. Allowable Broken Wires in Braided and Cable-Laid Slings.

Sling body	Allowable broken wires per lay or one braid	Allowable broken strands per sling length
Less than eight-part braid	20	1
Cable laid	20	1
Eight-part braid and more	40	1

5. Evidence of heat damage
6. End attachments that are cracked, deformed, or worn to the extent that the strength of the sling is substantially affected
7. Severe corrosion of the rope or end attachments
8. Hooks that have been opened more than 15 percent of the normal throat opening measured at the narrowest point or twisted more than 10E from the plane of the unbent hook.

Because many variable factors are involved, no precise inspection criteria can be given for determining the exact time for replacement of a sling. In this respect, safety depends largely on the use of good judgment by a qualified person in evaluating the remaining strength in a used sling after allowing for deterioration disclosed by inspection. Safety of sling operation depends on this remaining strength.

9.2.3.9 Operating Practices. Operating practices and guidelines for the use of wire rope slings are as follows.

1. Slings having suitable characteristics for the type of load, hitch, and environment shall be selected.
2. The weight of load shall be within the rated capacity of the sling.
3. Wire rope slings shall not be shortened or lengthened by knotting or twisting or with wire rope clips or other methods not approved by the sling manufacturer.
4. Slings that appear to be damaged shall not be used unless they are inspected and accepted as usable in accordance with the periodic inspection requirements stated above.
5. The sling shall be hitched in a manner providing control of the load.
6. Sharp corners in contact with the wire rope sling should be padded to minimize damage to the sling.

7. Portions of the human body should be kept from between the sling and the load and from between the sling and the crane hook or hoist hook.
8. Personnel should stand clear of the suspended load.
9. Personnel shall not ride the sling.
10. Shock loading is prohibited.
11. Slings should not be pulled from under a load when the load is resting on the sling.
12. Wire rope slings should be stored in an area where they will not be subjected to mechanical damage, corrosive action, moisture, extreme heat, or kinking.
13. Twisting and kinking the legs shall be avoided.
14. The load applied to the hook should be centered in the base (bowl) of the hook to prevent point loading of the hook, unless the hook is designed for point loading.
15. During lifting, with or without load, personnel shall be alert for possible snagging.
16. In a basket hitch, the load should be balanced to prevent slippage.
17. The sling's legs should contain or support the load so that the load remains under control.
18. Multiple-leg slings shall be selected so as not to introduce a working load in direct tension in any leg greater than that permitted. Triple- and quadruple-leg sling ratings should be considered the same as a double-sling rating because in normal lifting practice the load will not be uniformly distributed on all legs, leaving only two legs to carry the load. If rigging techniques--verified by a qualified rigger or rigging specialist--ensure the load is evenly distributed, then full use of three legs is allowed. Special rigging techniques verified by a qualified engineer shall be required to prove a load is evenly distributed over four or more sling legs.
19. Slings should be long enough so that the rated load is adequate when the angle of the legs is taken into consideration.
20. Slings should not be dragged on the floor or over an abrasive surface.
21. In a choker hitch, slings shall be long enough so that the choker fitting chokes on the wire rope body and never on the fitting.
22. Slings shall not be inspected by passing bare hands over the wire rope body. Broken wires, if present, may injure the hands.
23. Fiber core wire rope should not be subjected to degreasing or a solvent because it will damage the core.
24. Single-leg slings with hand-tucked splices can be unlaid by rotation. Care should be taken to minimize rotation.
25. An object engaging the eye of a loop eye sling should not be greater in width than one-half the length of the loop eye.

9.2.3.10 Cautions and Prohibitions. The sling's intended use shall determine the type of rope and termination. The following cautions and restrictions apply to this determination:

1. Rotation-resistant wire rope shall not be used for slings.
2. Wire rope clamps (clips) shall not be used to fabricate wire rope slings except when the application of the sling prevents the use of a prefabricated sling or when the specific application is designed by a qualified person (see Fig. 9-7). When used, slings fabricated using wire rope clamps shall be derated to 80 percent of the rated wire rope load capacity to account for the efficiency of the clamps. Wire rope clamps must be installed in accordance with the manufacturer's recommendations. The nuts on the clamps must be checked periodically and retorqued to the recommended value to maintain the efficiency rating. Slings made with wire rope clips should not be used as a choker hitch.
3. Wire rope wedge sockets shall not be used to fabricate wire rope slings.
4. Slings with eyes formed by folding back the rope (not a Flemish eye loop) and secured with one or more metal sleeves pressed (not forging) over the wire rope junction are prohibited for lifting service.

9.2.3.11 Onsite Sling Fabrication. Slings for lifting service may be fabricated onsite by knowledgeable craftsmen using one of the following methods:

1. Wire rope clips--This method shall be used only in special cases. The restrictions listed in para 9.2.3.10(2) shall be followed.
2. Hand tucked--The terminal efficiency is reduced (see Fig. 9-4). This sling type is usually more expensive than most commercially made slings.

Figure 9-7. Correct and Incorrect Ways to Use Wire Rope Clips (Clamps).

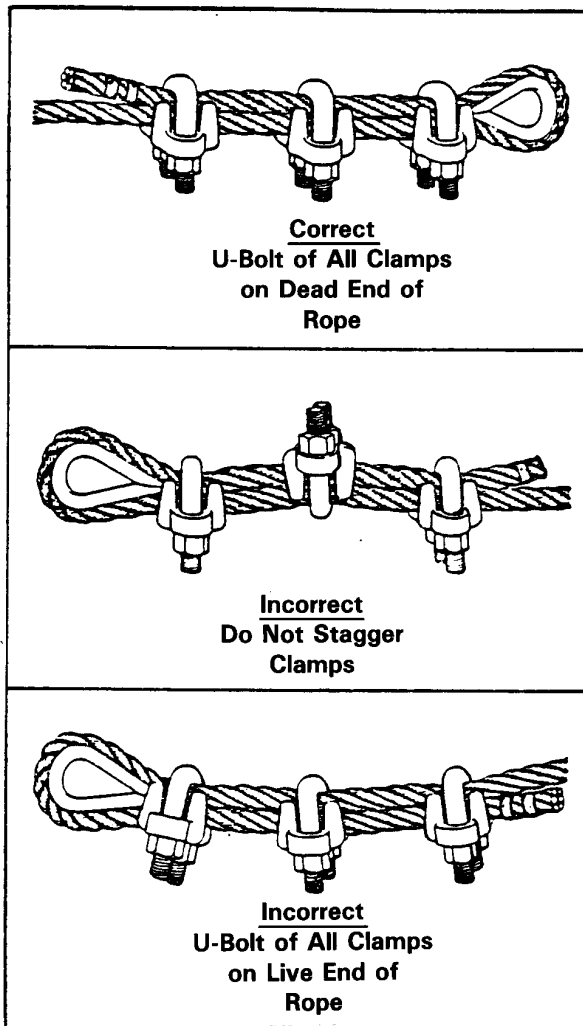

38805-185.7

NOTE: Number of clamps varies with rope size and construction.

3. Flemish eye with swaged socket--This is the best selection for general purposes and shall be used except when use is impractical.

Slings shall be made only from new wire rope. When swaged fittings are used, they shall be used as recommended by the fitting manufacturer and the swaging machine manufacturer. Thimbles should be used unless their use makes the sling impractical.

9.2.4 Metal Mesh Slings

Only commercially manufactured metal mesh slings shall be used. The configuration of metal mesh slings is shown in Fig. 9-8 and 9-9.

9.2.4.1 Sling Coatings. Slings may be painted, plated, impregnated, or molded with elastomers such as neoprene, polyvinyl chloride, urethane, or other suitable material. The coating shall not diminish the rated load of the sling.

9.2.4.2 Design Factor. The design factor for metal mesh slings shall be a minimum of 5.

9.2.4.3 Proof Tests. Metal mesh slings, new and repaired, shall be proof tested by the sling manufacturer or repair agency to a minimum of two times their rate load. Coated slings shall be proof tested before coating.

9.2.4.4 Identification. Metal mesh slings shall be labeled by the manufacturer with permanently affixed durable identification stating the following:

1. Manufacturer's name or trademark
2. Rated load in vertical, basket hitch, and choker hitch
3. An additional tag, sticker, or other identifier shall be added by the user to indicate when the next periodic inspection is required.

9.2.4.5 Proper Use of Metal Mesh Slings.

9.2.4.5.1 Rated Load. Metal mesh slings shall not be used to lift loads in excess of those specified by the manufacturer.

9.2.4.6 Effects of Environment. Chemically active environments can destroy the strength of metal mesh slings. Sling material can be susceptible to caustic damage or acid or acid fumes. Strongly oxidizing environments attack all common types of sling material. The manufacturer should be consulted before slings are used in chemically active environments. Specific environmental limits are as follows:

1. Metal mesh slings may be used without derating in a temperature range from -20 EF (-29 EC) to 550 EF (288 EC) except elastomer-coated slings.

Figure 9-8. Metal Mesh Fabric.

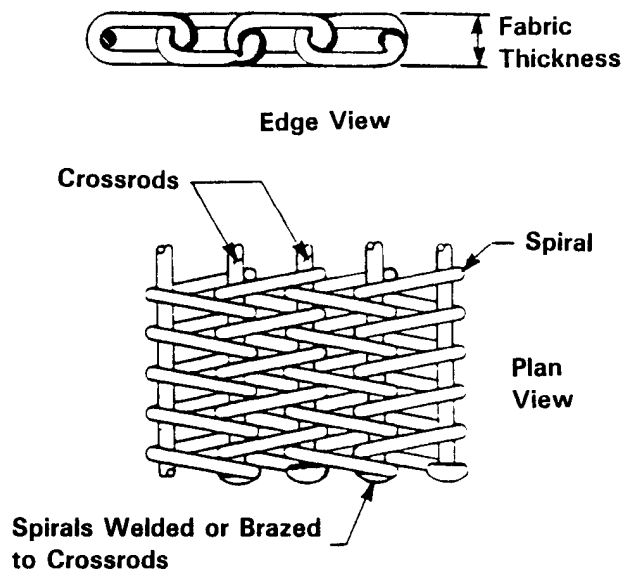
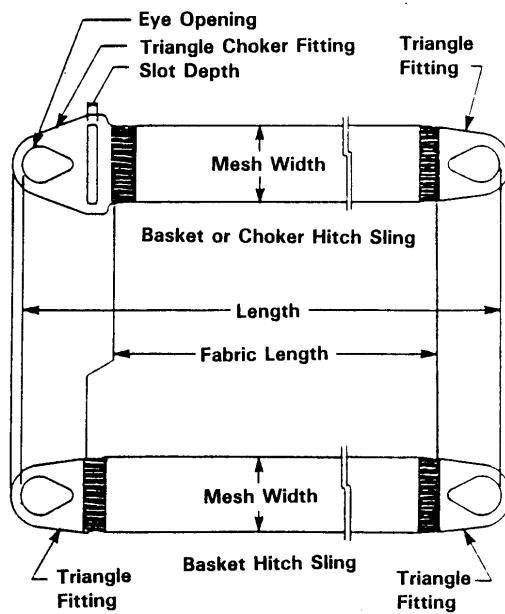

Figure 9-9. Metal Mesh Sling.



2. Elastomer-coated metal mesh slings shall be used in a temperature range from 0 EF (-18 EC) to 200 EF (93 EC).
3. For operation at temperatures outside these ranges or for special coatings, the manufacturer should be consulted for specific data.

9.2.4.7 Inspection.

9.2.4.7.1 Initial Inspection. Before any new or repaired sling is used, it shall be inspected to ensure that the correct sling is being used as well as to determine that the sling has proper identification.

9.2.4.7.2 Frequent Inspection. This inspection should be made by the person handling the sling each day the sling is used.

9.2.4.7.3 Periodic Inspection. A periodic inspection shall be performed by a qualified inspector on a regular basis with frequency of inspection based on the following criteria:

1. Frequency of sling use
2. Severity of service conditions
3. Nature of lifts being made
4. Experience gained on the service life of slings used in similar circumstances.

The periodic inspection shall be made at least annually and shall be documented by any one of the following methods:

1. Mark a serial number on the sling and maintain inspection records by serial numbers.
2. Institute a comprehensive marking program (such as color coding) to indicate when the next periodic inspection is required.
3. Mark each sling with a tag that indicates when the next periodic inspection is required. This tag becomes the record.

9.2.4.8 Removal Criteria. The periodic inspection shall be performed by a qualified person. Inspection shall be conducted on the entire length of each sling including attachments and fittings. Slings shall be removed from service if damage such as the following is visible:

1. Broken weld or a broken brazed joint along the sling edge
2. Broken wire in any part of the mesh
3. Reduction in wire diameter of 25 percent resulting from abrasion or 15 percent resulting from corrosion
4. Lack of flexibility resulting from distortion of the mesh

5. Distortion of the choker fitting so the depth of the slot is increased by more than 10 percent
6. Distortion of either end fitting so the width of the eye opening is decreased by more than 10 percent
7. A 15 percent reduction of the original cross-sectional area of metal at any point around the hook opening of end fitting
8. Visible distortion of either end fitting out of its plane
9. Cracked end fitting.

9.2.4.9 Repairs. Metal mesh slings shall be repaired only by a metal mesh sling manufacturer or a metal mesh sling qualified service center.

When repaired, a sling shall be permanently marked to identify the repairing agency.

All repaired mesh slings shall be proof-load tested (two times rated load).

9.2.4.10 Operating Practices. Operating practices and guidelines for the use of metal mesh slings are as follows.

1. Slings having suitable characteristics for the type load, hitch, and environment shall be selected.
2. The weight of the load shall be within the rated load of the sling.
3. Slings shall not be shortened or lengthened by knotting or other methods not approved by the sling manufacturer.
4. Slings that appear to be damaged shall not be used unless they are inspected and accepted as usable in accordance with the periodic inspection requirements stated above.
5. The sling shall be hitched in a manner providing control of the load.
6. Sharp corners in contact with the sling should be padded to minimize damage to the sling.
7. Portions of the human body should be kept from between the sling and the load and from between the sling and the crane hook or hoist hook.
8. Personnel should stand clear of the suspended load.
9. Personnel shall not ride the sling.
10. Shock loading is prohibited.
11. Slings should not be pulled from under a load when the load is resting on the sling.
12. Slings should be stored in an area where they will not be subjected to mechanical damage, corrosive action, moisture, extreme heat, or kinking.
13. Twisting and kinking the legs shall be avoided.

14. During lifting, with or without load, personnel shall be alert for possible snagging.
15. In a basket hitch, the load should be balanced to prevent slippage.
16. Slings should not be dragged on the floor or over an abrasive surface.
17. In a choker hitch, slings shall be long enough so that the choker fitting chokes on the mesh and never on the other fittings.
18. In a choker hitch, the load should be balanced to prevent edge overload.
19. A sling in which the spirals are locked or without free articulation shall not be used.
20. A sling shall never be hammered to straighten a spiral or cross rod or to force a spiral into position.
21. Slings used in pairs should be attached to a spreader beam.

9.2.5 Synthetic Web Slings

9.2.5.1 Construction.

9.2.5.1.1 Webbing. Synthetic web slings fabricated by sewing woven synthetic webbing of nylon or polyester yarns form the basic sling types shown in Fig. 9-10 and 9-11. Webbing shall have the following characteristics:

1. Sufficient certified tensile strength to meet the sling manufacturer's requirements
2. Uniform thickness and width
3. Full woven width, including selvage edges
4. Webbing ends sealed by heat, or other suitable means, to prevent raveling
5. Stitching shall be the only method used to attach end fittings to webbing and to form eyes.

9.2.5.1.2 Fittings. If synthetic web slings incorporate metal fittings, the fittings shall have the following properties:

1. Fittings shall have sufficient strength to sustain twice the rated load of the sling without permanent deformation and a minimum breaking strength equal to five times the rated capacity of the sling.
2. Surfaces shall be cleanly finished and sharp edges removed to prevent damage to the webbing.
3. Slings incorporating reused or welded fittings shall be proof tested to two times the rated load of the sling.
4. Slings incorporating aluminum fittings shall not be used where fumes, vapors, sprays, mists or liquids of caustics, or acids are present.

5. The eye opening in the fitting shall be the proper shape and size to ensure that the fitting will seat properly in the hook or other attachment.

9.2.5.1.3 Coatings. Synthetic web slings may be coated with suitable material that will impart the following desirable characteristics:

1. Abrasion resistance
2. Sealing to prevent penetration of foreign particles and matter
3. Increased coefficient of friction
4. Protection from sunlight or ultraviolet degradation.

Figure 9-10. Synthetic Web Slings.

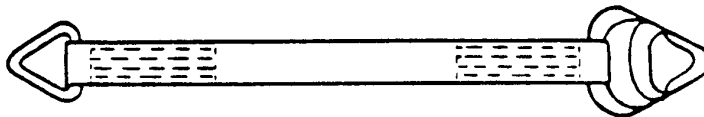

- Type I** Sling made with a triangle fitting on one end and a triangle choker fitting on the other end. It can be used in a vertical, basket, or choker hitch.

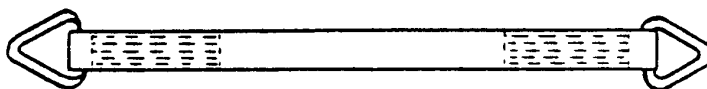

- Type II** Sling made with a triangle fitting on both ends. It can be used in a vertical or basket hitch only.

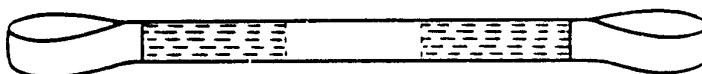

- Type III** Sling made with a flat loop eye on each end with loop eye opening on same plane as sling body. This type of sling is sometimes called a flat eye and eye, eye and eye, or double eye sling.

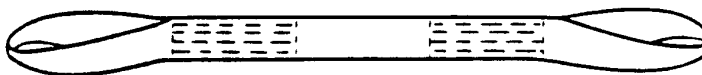

- Type IV** Sling made with both loop eyes formed as in Type III, except that the loop eyes are turned to form a loop eye which is at a right angle to the plane of the sling body. This type of sling is commonly referred to as a twisted eye sling.

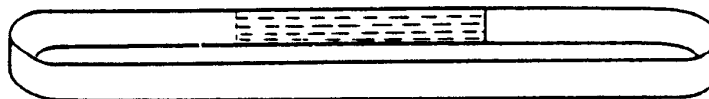

- Type V** Endless sling, sometimes referred to as a grommet. It is a continuous loop formed by joining the ends of the fabric together with a splice.



- Type VI** Return eye (reversed eye) sling is formed by using multiple widths of webbing held edge to edge. A wear pad is attached on one or both sides of the sling body and on one or both sides of the loop eyes to form a loop eye at each end which is at a right angle to the plane of the sling body.

Figure 9-11. Web Sling With Loop Eyes or End Fittings.

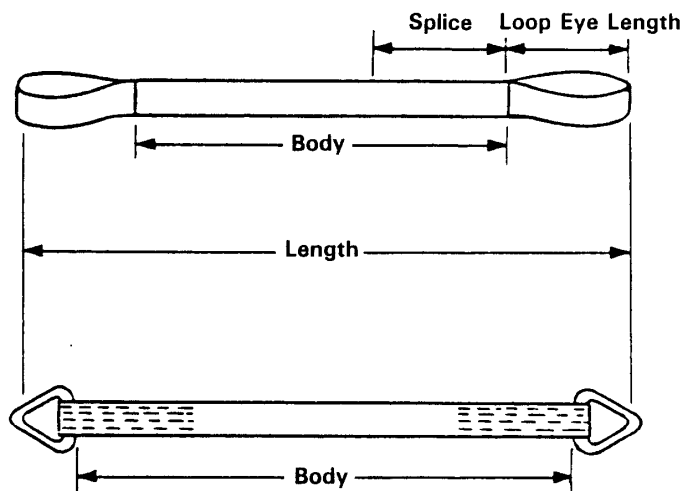

Body - That Part of a Sling Which is Between the End Fittings or Loop Eyes

Length - The Distance Between Extreme End Bearing Points of the Sling, Including the Fittings

(a)



(Two or more Widths of Web Joined Side by Side with a Narrower Width of Web)

(Two or more Widths of Web Joined Side by Side with a Full Width of Web)

(b) Assembly Splice

9.2.5.1.4 Marking (Sling Identification). Synthetic web slings shall be labeled (a sewn-on leather tag is recommended). The label shall state the following:

1. Manufacturer's name or trademark
2. Manufacturer's code or stock number
3. Rated loads for the types of hitches used
4. Type of synthetic web material
5. An additional tag, sticker, or other identifier shall be added by the user to indicate when the next periodic inspection is required
6. If the synthetic web sling is to be used for critical lifts, the tag or other identification means shall be used to indicate that a proof test has been performed.

9.2.5.2 Design Factor. The design factor for synthetic web slings shall be a minimum of 5.

9.2.5.3 Rated Load. A synthetic web sling shall not be used at a load greater than shown on its tag. Each manufacturer shall make available on request test data to justify the rated loads.

1. Bridle slings. For rated loads of bridle slings, where both legs are not vertical and for consideration of the angle between basket hitch slings, the following equation shall be applicable.

$$\text{rated load} = \text{vertical rated load} \times \text{number of legs} \\ \times \text{sine of minimum horizontal angle}$$

2. Choker hitch. The rated load, in choker hitch, of single-leg slings shall be a maximum of 80 percent of the vertical rated load.

9.2.5.4 Proof Tests. When specified by the purchaser, web slings of all types shall be proof loaded by the manufacturer. Synthetic web slings used for a critical lift shall be proof loaded. Proof loading may be done on site or by the sling manufacturer (see para 9.2.5.1.4 for proof-test marking).

9.2.5.4.1 Single-Leg and Endless Slings. The proof load for single-leg and endless slings shall be two times the vertical rated load.

9.2.5.4.2 Multiple-Leg Bridle Slings. The proof load for multiple leg bridle slings shall be applied to the individual legs and shall be two times the vertical rated load of a single-leg sling.

9.2.5.5 Effects of Environment. High radiation or chemically active environments can destroy the strength of synthetic web slings. Sling materials can be susceptible to caustics and acids. The manufacturer should be consulted before slings are used in chemically active environments. Radiation degrades synthetic material. Specific environmental limits are as follows:

1. Nylon and polyester slings shall not be used at temperatures in excess of 180 EF.

2. Synthetic slings, including Kevlar,³ K-Spec,⁴ nylon, and polyester may be used in radiation areas only when the responsible person ensures that the absorbed dose shall not exceed 100,000 rad during the life of the sling.
3. Synthetic web slings that incorporate aluminum fittings shall not be used where fumes, vapors, sprays, mists, or liquids of caustics or acids are present.
4. Nylon web slings shall not be used where fumes, vapors, sprays, mists or liquids of acids or phenolics are present.
5. Polyester web slings shall not be used where fumes, vapors, sprays, mists, or liquids or caustics are present.
6. Synthetic web slings are not recommended where extensive exposure to sunlight or ultraviolet light is experienced (see para 9.2.5.9[22], "Operating Practices").

9.2.5.6 Inspection.

9.2.5.6.1 Initial inspection. Before any new or repaired synthetic web sling is used, it shall be inspected to ensure that the correct sling is being used as well as to determine that it has proper identification.

9.2.5.6.2 Frequent Inspection. This inspection should be made by the person handling the sling each day the sling is used.

9.2.5.6.3 Periodic Inspection. A periodic inspection shall be performed by a qualified inspector on a regular basis with frequency of inspection based on the following criteria:

1. Frequency of sling use
2. Severity of service conditions
3. Nature of lifts being made
4. Experience gained on the service life of slings used in similar circumstances.

The periodic inspection shall be made at least annually and shall be documented by any one of the following methods:

1. Marking a serial number on the sling and maintaining inspection records by serial numbers
2. Instituting a comprehensive marking program (such as color coding) to indicate when the next periodic inspection is required
3. Marking each sling with a tag that shows when the next periodic inspection is required. This tag becomes the record.

³ Kevlar is a registered trademark of DuPont de Nemours.

⁴ K-Spec is a registered trademark of SlingMax.

9.2.5.7 Removal Criteria. Synthetic web slings shall be removed from service if damage such as the following is visible (see para 9.2.1.1):

1. Acid, phenolic, or caustic attack
2. Melting or charring on any part of the sling
3. Holes, tears, cuts, or snags
4. Broken or worn stitching in load-bearing splices
5. Excessive abrasive wear
6. Knots in any part of the sling
7. Excessive pitting or corrosion, or cracked, distorted or broken fittings
8. Other visible indications that cause doubt as to the strength of the sling, such as loss of color that may indicate the potential for ultraviolet light damage
9. If a synthetic sling located in a radiation area approaches its radiation exposure limit (100,000 rad during the life of the sling), it shall be removed from service. (See para 9.2.5.5, "Effects of Environment.")

9.2.5.8 Repairs. Synthetic web slings shall be repaired only by a sling manufacturer or a qualified repair agent. When repaired, a sling shall be permanently marked to identify the repair agent.

Temporary repairs of either webbing, fittings, or stitching shall not be permitted.

A repaired sling shall be proof tested to two times its assigned rated load before being put back into service.

9.2.5.9 Operating Practices. The following operating practices are applicable to the use of synthetic web slings:

1. Slings having suitable characteristics for the type of load, hitch, and environment shall be selected.
2. The weight of load shall be within the rated capacity of the sling. (The rated capacity is less than or equal to the rated load after sling angles and hitch type are considered.)
3. Slings shall not be shortened or lengthened by knotting or other methods not approved by the sling manufacturer.
4. Slings that appear to be damaged shall not be used unless they are inspected and accepted as usable in accordance with the periodic inspection requirements stated in para 9.2.5.6.3.

5. Slings shall be hitched in a manner providing control of the load.
6. Sharp corners in contact with the sling should be padded to minimize damage to the sling.
7. Portions of the human body should be kept from between the sling and the load, and from between the sling and the crane hook or hoist hook.
8. Personnel should stand clear of the suspended load.
9. Personnel shall not ride the sling.
10. Shock loading is prohibited.
11. Slings should not be pulled from under a load when the load is resting on the sling.
12. Slings should be stored in a cool, dry, and dark place to prevent environmental damage.
13. Twisting and kinking the legs shall be avoided.
14. Load applied to the hook should be centered in the base (bowl) of hook to prevent point loading on the hook.
15. During lifting, with or without load, personnel shall be alert for possible snagging.
16. In a basket hitch, the load should be balanced to prevent slippage.
17. The sling's legs should contain or support the load from the sides above the center of gravity when a basket hitch is used.
18. Slings should be long enough so that the rated load is adequate when the angle of the legs is taken into consideration.
19. Slings should not be dragged on the floor or over an abrasive surface.
20. In a choker hitch, slings shall be long enough so the choker fitting chokes on the webbing and never on the other fitting.
21. Nylon and polyester slings shall not be used at temperatures in excess of 180 EF.
22. Nylon and polyester web slings lose strength from extensive exposure to sunlight or ultraviolet light. Possible strength loss may be indicated by loss of color in the pick threads or outer jacket. If the user suspects sunlight or ultraviolet light damage the sling shall be taken out of service pending inspection by a qualified person.
23. The use of synthetic slings should be avoided in radiation areas. For further information, see para 9.2.5.5, item 2.
24. Hard or brittle spots in the fabric of synthetic slings may indicate a substantial reduction in strength as a result of damage from chemicals or excessive heat.